

Technical data sheet

Clamp clip, single, FT plastic pressure trough

Item number: 1169408



Suitable for flat, bracket and U irons of 4–12 mm material thickness.
Clip and bolt made of hot-dip galvanised steel.
Polypropylene pressure trough, halogen-free, colour light grey RAL 7035.
Version with welding and/or locknuts for use under difficult circumstances and for shake protection on request.



St Steel

FT Hot-dip galvanised

Master data

Item number	1169408
Description 1	Clamp clip
Manufacturer	OBO
Dimension	34-40mm
Material	Steel
Surface	Hot-dip galvanised
Surface standard	DIN EN ISO 1461
Smallest sales unit	100
Unit of quantity	Piece
Weight	8.5 kg
Weight unit	kg/100 pc.
CO Footprint (GWP) Cradle-to-Gate	0,1535 kg COe / 1 Piece

Technical data sheet

Clamp clip, single, FT plastic pressure trough



Item number: 1169408

Dimensions

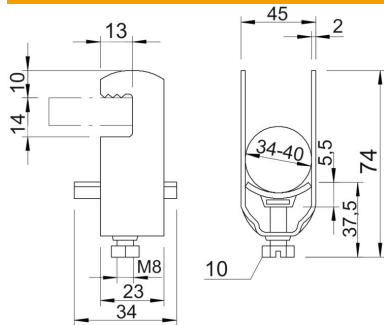

Dimension A	23 mm
Dimension B	45 mm
Dimension C	34 mm
Dimension E	13 mm
Dimension G (mm)	M8
Dimension H	74 mm
Dimension L	37.5 mm
Dimension t	2 mm
Dimension x	5.5 mm

Technical data

Number of cables/pipes	1
for 1 cable H	74 mm
for 1 cable L	37.5
for 2 cable H	116 mm
for 2 cable L	44.5 mm
for 3 cable H	159 mm
for 3 cable L	56.5 mm
For pipe diameter, max.	40 mm
For pipe diameter, min.	40 mm
Halogen-free	yes
Max. Tightening torque	5 Nm
With plastic trough	yes
With metal trough	no
Mounting type	Flat profile
Impact-resistant	no
Clamping range D, max.	40 mm
Clamping range D, min.	34 mm
Surface addition	hot galvanised
Material addition	Steel
With counter-trough	no
Material of trough	Plastic
Material quality of trough	Polypropylene